

# Markisen BOOM

## Seilmarkisen BOOM med motor

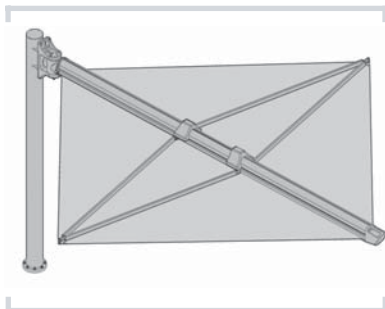

### Standard utførelse:

Overflatebehandling: Støpte deler i RAL 9006, Profiler eloksert i E6/EV1 i kvalitet 25μ

Drift: Motor og 3-D-Vindsensor

Tekstil: Sunsilik.

Pris for Standardutførelse (Pris på Boom uten bakkefestet stolpe)

Modell	Utfall	Bredde	Overflate	Vekt	Pris
BOOM 1	4000	2885	8,5m <sup>2</sup>	125kg	63 747,-
BOOM 2	4500	3238	11m <sup>2</sup>	133kg	65 448,-
BOOM 3	5000	3535	13,5m <sup>2</sup>	141kg	68 346,-
BOOM 4	5500	3890	16m <sup>2</sup>	149kg	73 305,-

### BOOM 1 – 8,5m<sup>2</sup>

For hjørnemontering og små sittegrupper.

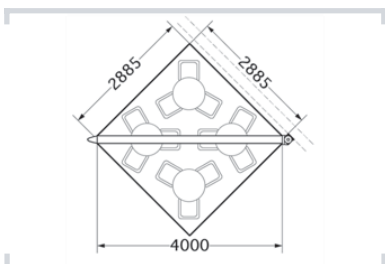

### BOOM 2 – 11m<sup>2</sup>

For Haven, terrassen og Bassengkanten

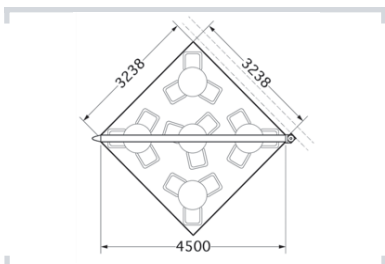

### BOOM 3 – 13,5m<sup>2</sup>

For spa anlegg, hotell, cafe og restauranger.

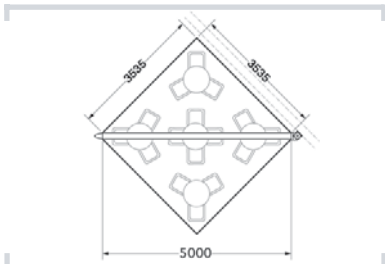

### BOOM 4 – 16m<sup>2</sup>

For Bar, Hotell og Restauranger

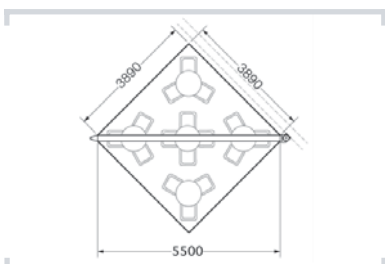

### Pristillegg og prisfradrag for markisen BOOM

Modell	Beskrivning	Pris
KU	Prisminkning for sveivdrift	-3 420,-
NHK	Pristillegg for motordrift samt nøddrift med sveiv	3 060,-
SOFA	Aristillegg for konsoll, Luftvogn og spiss i "SOFA"	5 445,-
SOFA	Pristillegg for profiler i eget fargevalg	5 445,-
„Marine“	Pristillegg for "Marine-Pakke" Høyglans Krom	17 550,-
	Pristillegg for utførelse i "saltvannbeskyttet"	1 620,-
	Pristillegg for spotlightpakke(3 spot + dimmer)	9 684,-
	Pristillegg for ekstra spot til spotlightpakken	1 593,-
	Pristillegg for 4 kanals fjernkontroll	621,-
	Pristillegg for beskyttelsestrekk for vinterlagring	2 700,-

# Markisen BOOM - Bakkefeste

## Priser bakkester for Seilmarkisen BOOM

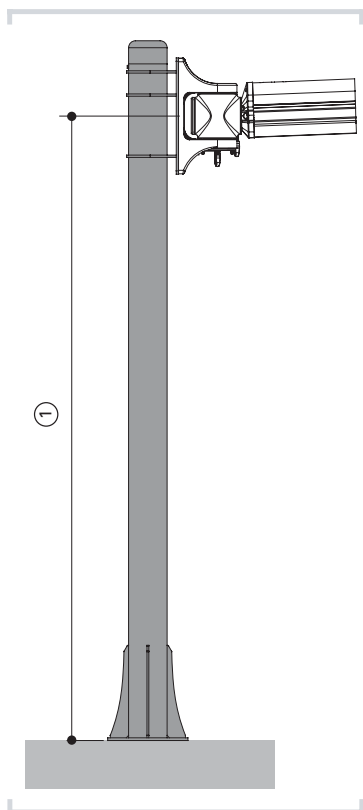

Høyde [mm]	Bakkestolpe for 1 BOOM			Bakkefeste for 2 BOOM		
	Forsinket	PB	Edelstål	Forsinket	PB	Edelstål
2000	9441	11889	15534	12780	15228	24291
2250	9540	11988	15723	12996	15444	25317
2500	9639	12087	15912	13221	15669	26352
2750	9738	12186	16101	13437	15885	27378
3000	9738	12186	16272	13653	16101	28395

Høyde H [mm]	Bakkefeste 3 BOOM			Bakkefeste 4 BOOM		
	Forsinket	PB	Edelstål	Forsinket	PB	Edelstål
2000	13527	15975	25830	14292	16740	27288
2250	13743	16191	26856	14508	16956	28314
2500	13968	16416	27882	14733	17181	29358
2750	14184	16632	28899	14949	17397	30366
3000	14400	16848	29934	15165	17613	31392

**Bolter for feste mot bakke er ikke med i prisen!**

\* Edelstål 1.4301 (Andre materialer på forespørsel)

### Lengde

① Høyde H

### Stolpevarianter

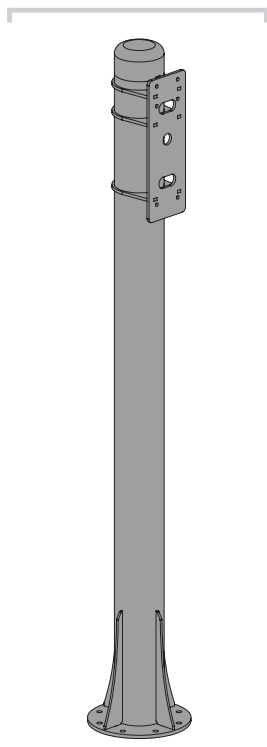

Stolpe for 1 BOOM

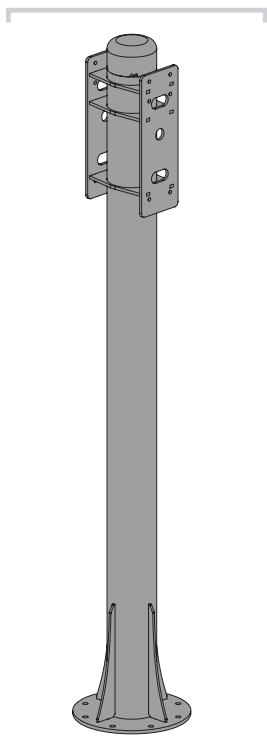

Stolpe for 2 BOOM

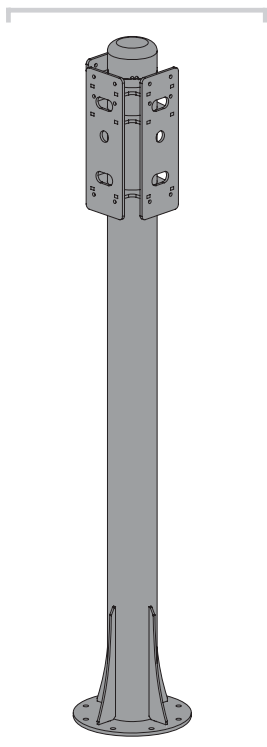

Stolpe for 3 BOOM

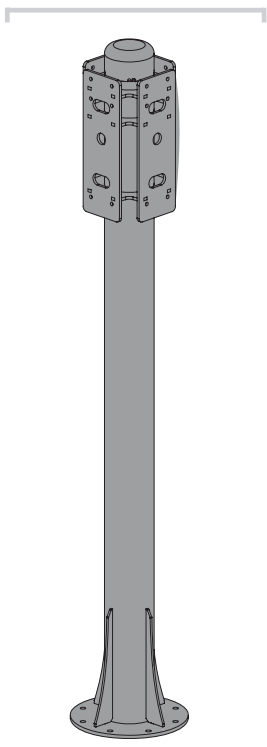

Stolpe for 4 BOOM

### Betonganker for feste i betong

Anker	Pris / Anker	Anker / Antall	Samlet pris
FAZ 16/50 A4	165,60	8	1 324,80